

SOLUTIONS THAT COMPLETE!

GARZ FRICKE

NESO LT 4.3 OF
ARM9 Rear Mount

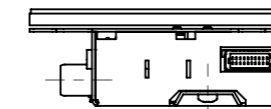
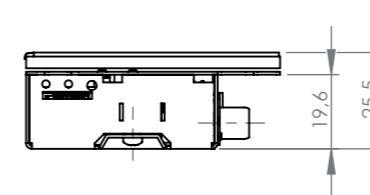
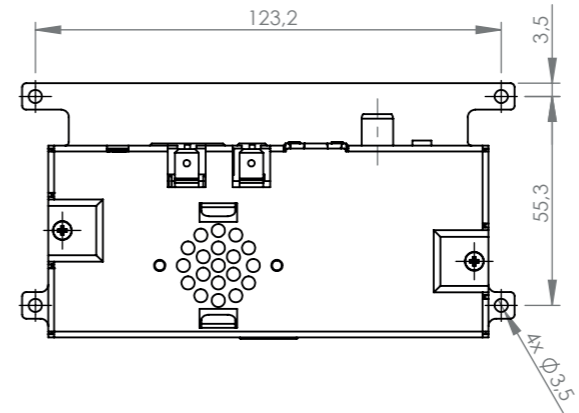
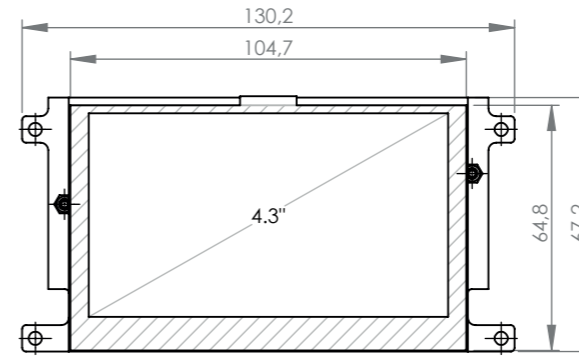
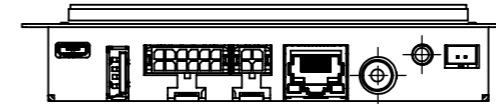
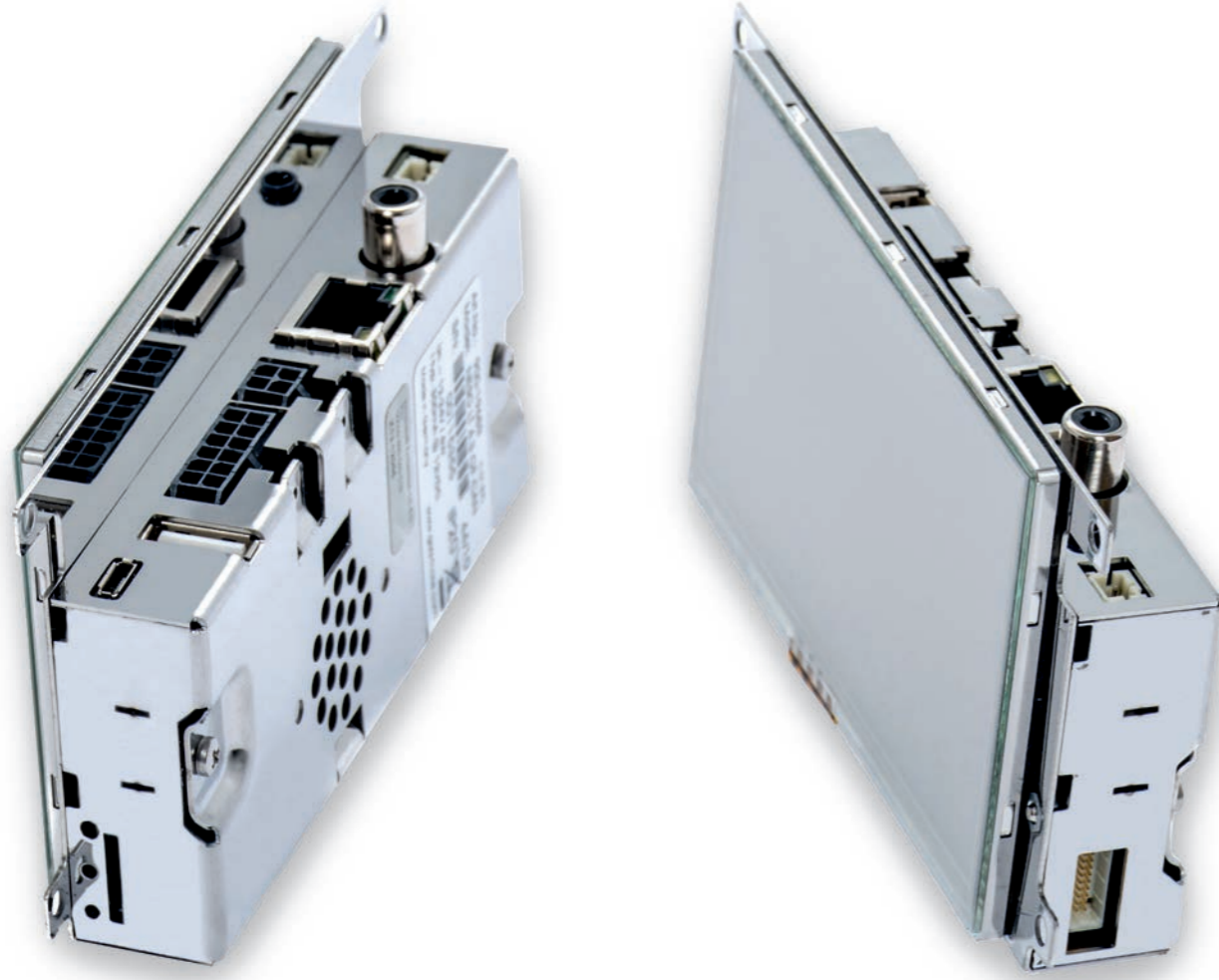

TECHNICAL SPECIFICATION
NESO LT 4.3 OF

CPU	RS-485	CAN
CPU Type	i.MX 257	
Core Class	ARM 926	
Core Clock	400 MHz	
Features	16 KB for Instruction and data caches	
RTC	Accuracy: +/- 30 ppm at 25°C	
Memory		
NAND Flash	256MByte NAND Flash	
RAM Standard	128 MByte DDR-SDRAM	
Micro SD Card Slot	4 bit MicroSD (HC)	
Operating Systems		
Supported OS	Windows CE 6.0, Linux Yocto	
Communication Interfaces		
Digital I/O	1x Digital Out (0.7 A)	
Network	1x 10/100 Mbit/s Ethernet (RJ-45)	
RS-485 / CAN Fieldbus	1x RS-485 (Half duplex)	1x CAN (ISO/DIS 11898)
RS-232	1x RS-232 (RX/TX/CTS/RTS)	
Synchronous Serial Interfaces	SPI (10 MBit/s) up to 12 chip selects; I ² C, Matrix keypad up to 8 x 8	
High-Speed USB 2.0	1x 12 Mbit/s Full Speed Host 1x 480 Mbit/s High Speed OTG	
Audio		
Speaker output	1x speaker (connector), 1.0 W RMS (8Ω)	
Audio Internal	1x speaker 0.3 W RMS (8Ω)	
Display and Touch		
Size	4.3 inch/109.3 mm	
Resolution	480 x 272 pixel	
Brightness	Typ. 350 cd/m ²	
Backlight Lifetime	tbd.	
Viewing Angle	60°, 65°, 70°, 70° (UDRL)	
Color	24 bit [16.7 Mio. colors]	
Touch	4 wire resistive	
Housing		
Metal Parts	1.4016 high quality steel 0.8 mm	
Front	Surface Hardness 3H; antiglare	
Device Dimensions		
W x H x D	130.2 x 67.2 x 25.5 mm	
Weight	190 g	
Power Supply		
Supply Voltage	Nom. 9 to 16 V DC	
Consumption	Typ. 2.1 W; max. 9 W	
Typical Environmental Conditions		
Storage Temp.	-20 to +70 °C	
Operating Temp.	0 to +60 °C	
Humidity	5 to 90 % RH	

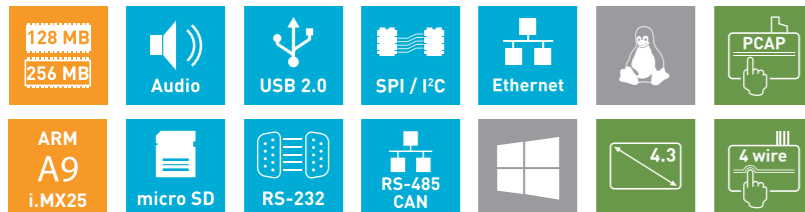

Online support on www.garz-fricke.com

„This product can be modified by alternative assembly. Please contact us for available options.“